

# +GF+ SIGNET 5091 ProPoint™ Current Monitor



## Features

- High Visibility Analog Display
- Reversible Dial: 4 to 20 mA or 0 to 100%
- Assorted Decals Included for Customizing Display
- Wire in series with 4 to 20 mA loop. No additional power required.
- 1/4 DIN, NEMA 4X/IP65 Enclosure
- Hard-coated, High Impact & UV Resistant Polycarbonate Front Face
- Quality Standards: CE

## Application

4 to 20 mA loop monitoring, or 0 to 100% for ANY process variable such as:

- Flow
- pH/ORP
- Conductivity/Resistivity
- Pressure
- Temperature
- Valve Position
- Level
- Specific Ion
- Dissolved Oxygen, BOD
- TOC
- Turbidity
- Hardness

## Description

Simply wire the +GF+ SIGNET 5091 Current Monitor in series with any 4 to 20 mA loop, and obtain a visual indication of process conditions anywhere in your plant. No additional power or connections are required. A reversible slide-in dial is provided to display either the 4 to 20 mA loop signal directly, or

0 to 100% (of full scale). The needle is capable of dropping below 4 mA and pegging above 20 mA, so unusual conditions are easy to recognize. An assortment of decals is included to customize the display for any process variable.

## Technical Features

Pro-Point Family Features

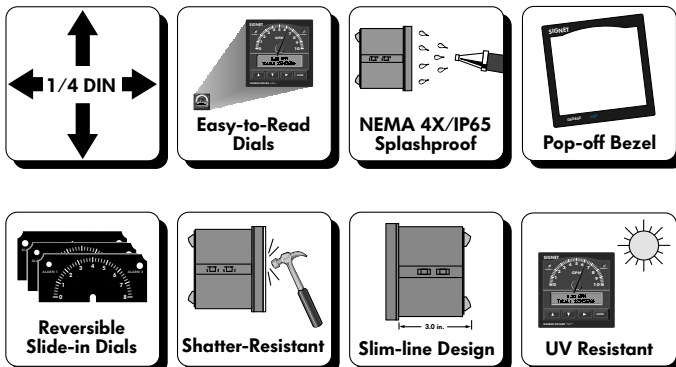

## Options

Any 4 to 20 mA loop, including +GF+ SIGNET Transmitters, ProPoint™ Monitors, Intelek-Pro™ Controllers and sensors shown here:

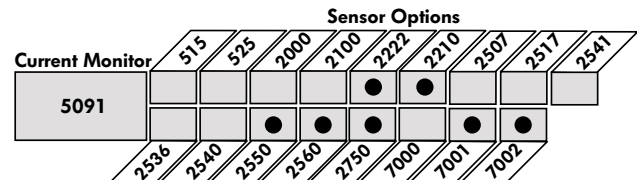

## Dimensions

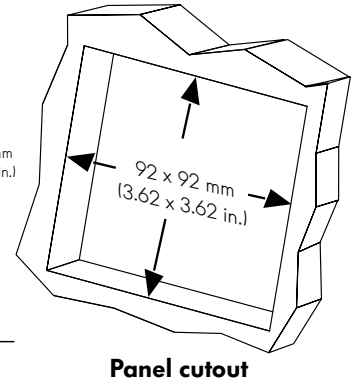
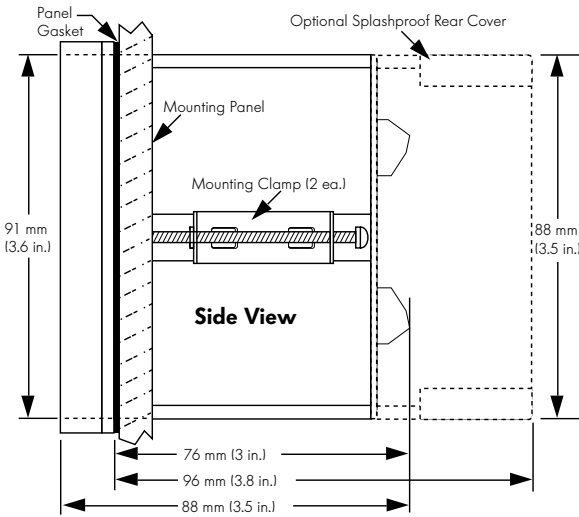
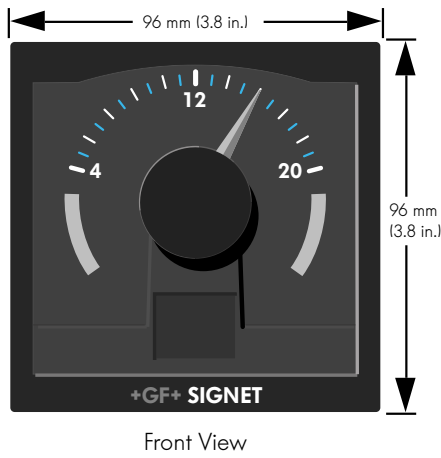

## Installation

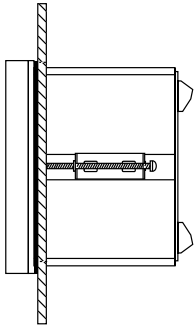

- Panel mount (standard)

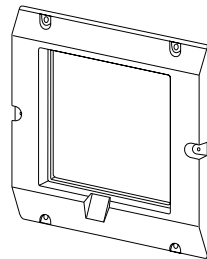

- Optional 5 x 5 inch adapter plate for SIGNET retrofit (3-5000.399)

- Standard 1/4 DIN panel cutout
- 76 mm (3 in.) mounting depth including rear terminals
- The front panel provides NEMA 4X/IP65 protection.
- Optional splashproof rear cover kit with knockout ports for cable access.
- 96 mm (3.8 in.) mounting depth with optional splashproof rear cover installed

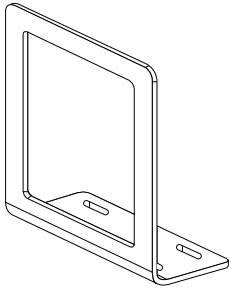

- Optional surface mounting bracket (3-5000.598)

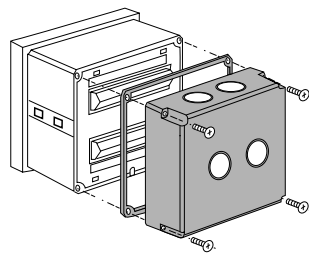

- Optional splashproof rear cover kit (NEMA 4X/IP65) (3-5000.395)

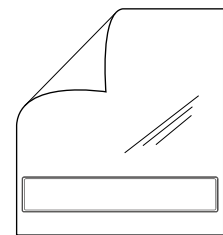

- Protective Overlay kit (10 pcs) (3-5000.398)

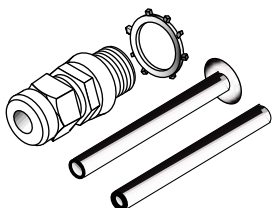

- Liquid Tight Connector Kit (3-9000.392 - 3 sets per kit) (3-9000.392-1 - 1 set per kit)

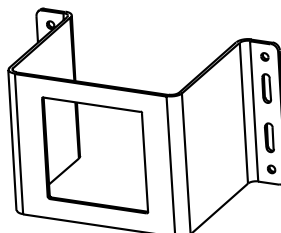

- Optional heavy duty wall mount bracket (3-0000.596)

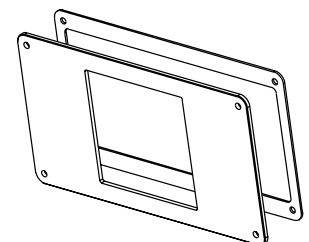

- Optional 200 retrofit adapter (3-8050.392)

## Rear Terminal View

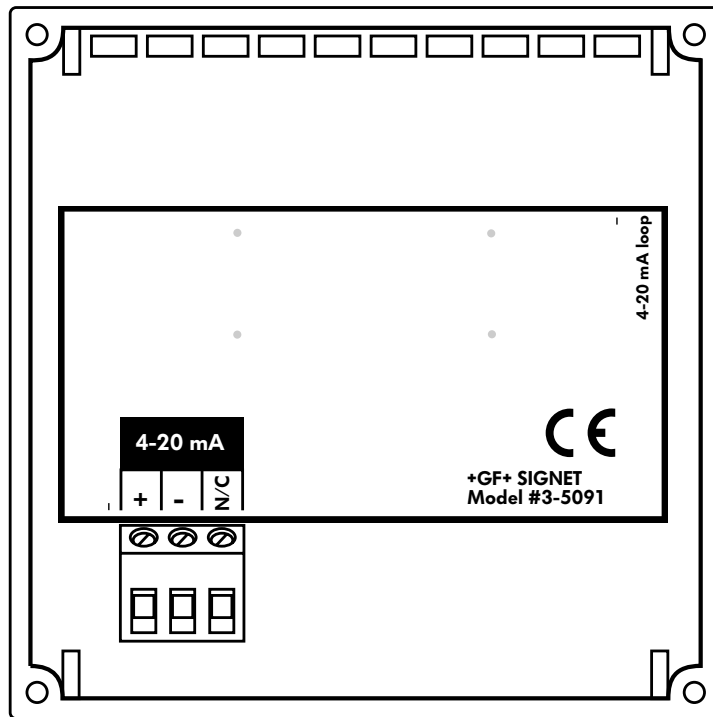

## Technical Data

### General

Operating Range:	4 to 20 mA (factory calibrated)
Power Requirements:	none
Max. Voltage Drop:	2.5 VDC at 20.00 mA
Display:	Taut-band suspension meter movement, 250° deflection (not suitable for prolonged exposure to vibration)
Accuracy:	+/- 2% of full scale
Repeatability:	+/- 1% of full scale
Materials:	Enclosure: ABS Plastic, NEMA 4X/IP65 Panel and case gasket: Neoprene Window: Hard-coated polycarbonate
Shipping Weight:	0.5 kg (1.1 lbs.)

### Environmental

Operating Temperature:	-10 to 65°C (14 to 149 °F)
Storage Temperature:	-15 to 80°C (5 to 176 °F)
Relative Humidity:	0 to 95%, non-condensing

### Standards and Approvals

- CE
- Manufactured under ISO 9001 and ISO 14001
- Immunity: EN50082-2
- Emissions: EN55011
- Safety: EN61010-1

## Ordering Information

Mfr. Part No	Code	Description
3-5091	198 825 010	Current Monitor

## Accessories

Mfr. Part No	Code	Description
3-5000.395	198 840 227	Splashproof Rear Cover Kit (NEMA 4X/IP65)
3-9000.392	159 000 368	Liquid tight connector kit for rear cover (includes 3 connectors)
3-9000.392-1	159 000 839	Liquid tight connector kit, NPT (1 piece)
3-9000.392-2	159 000 841	Liquid tight connector kit, PG13.5 (1 piece)
3-5000.399	198 840 224	5 x 5 inch adapter plate for +GF+ SIGNET retrofit
3-5000.598	198 840 225	Surface mount bracket
3-0000.596	159 000 641	Heavy duty wall mount bracket
3-5000.390	159 000 323	Installation kit
3-5000.396	159 000 325	5090 window kit
3-5000.525-1	198 840 226	Bezel, 5000 series
3-5091 .611	159 000 339	Unit tags
3-5000.398	159 000 646	Protective Overlay kit (10 pcs.)
3-8050.392	159 000 640	Model 200 Retrofit Adapter

## Engineering Specifications

- The current monitor shall meet appropriate CE standards, including EN50082-2 requirements for electromagnetic immunity, EN55011 requirements for electromagnetic emissions, and EN61010-1 for safety.
- The current monitor shall be manufactured under ISO 9001 and ISO 14001 certified processes.
- The current monitor shall include a taut-band suspension meter movement providing 250° deflection.
- The current monitor shall accept replaceable dial faces, provided by the manufacturer, to display a variety of engineering units in ranges including: 4 to 20 mA and 0% to 100%, with open-loop and over-range indication.
- The current monitor shall operate on current loop power in the range of 4 mA to 20 mA, with a max. voltage drop of 2.5 VDC at 20.00 mA.
- Current monitor accuracy shall be  $\pm 2\%$  of full scale, with repeatability of  $\pm 1\%$  of full scale.
- The current monitor shall be +GF+ SIGNET 5091 Current Monitor.